



# GM861/GM861-LED Bar Code Reader Module User Manual



**GM861**



**GM861-LED**

Hangzhou Grow Technology Co., Ltd.  
V1.2.4 July. 2025

# Revised Version

Version Number	Date	Revise Content	Modifier
V1.1	2023.05	1. Add function: Through the serial port, send the serial command to enable or disable the setting code function.  (More details: 1.6 Setup Code)	Grow Tech
V1.2	2023.09	1. Added AIM serial instruction(Appendix B) 2. Added Micro PDF417, Micro QR, Aztec	Grow Tech
V1.2.1	2024.03	1. Added case setting code.(More details in 2.2.2) 2. Added Output Data code format RAW OUTPUT. (More details in 6.1) 3. Added prefix and suffix serial command. (More details in 10.6)	Grow Tech
V1.2.2	2025.05	1. Add 200ms/300ms/400ms setting code in command trigger mode.  (3.4 Command Triggered Mode ) 2. Modify the suffix zone bit and add suffix examples.(10.6 List of zone bit, Appendix B)	Grow Tech
V1.2.3	2025.05	Modify the setting code for "Change tail to "TAB". (7.6)	Grow Tech
V1.2.4	2025.07	1. Added GM861-LED version. 2. Added 5.2 Fill Lighting(For GM861-LED) 3. Updated 6. Prompts	Grow Tech

# Catalog

1. Introduction of Module .....	6
1.1 Introduction .....	6
1.1.1 Read Version Information .....	6
1.1.2 Read the Unique Device ID .....	6
1.2 Technical Specification .....	7
1.3 Electrical Characteristics .....	9
1.3.1 Power Supply Requirements .....	9
1.3.2 Ripple noise .....	9
1.4 Dimension(mm)&Pin Definition .....	10
1.5 Scan Area .....	12
1.6 Setup Code .....	12
1.7 Save and Cancel .....	13
1.8 Reset .....	13
1.9 User Default Settings .....	14
2 Communication interface .....	15
2.1 Serial Communication Interface .....	15
2.1.1 Serial Port Check Bit Configuration .....	16
2.1.2 Serial Port Calibration .....	16
2.2 USB HID Interface .....	17
2.2.1 HID Type Device Selection .....	17
2.2.2 HID Parameter Configuration .....	17
2.2.3 HID Lead Key Output .....	19
2.3 USB HID-KBW .....	20
2.3.1 HID-KBW Device Mode .....	20
2.3.2 HID-KBW Serial Output at the Same Time .....	20
2.4 USB HID-POS .....	20
2.4.1 HID-POS Device Mode .....	20
2.4.2 HID-POS HID-KBW Output at the Same Time .....	21
2.5 USB Virtual Serial Port .....	21
3 Read Mode .....	22
3.1 Continuous Mode .....	22
3.2 Induction Mode .....	23
3.3 Manual Mode .....	25
3.3.1 Trigger Mode .....	26
3.3.2 Sleep Mode Choice .....	26
3.3.3 Idle Time For Sleep Mode .....	26
3.4 Command Triggered Mode .....	27
3.5 POS Mode .....	28
4 Read area .....	29
4.1 Full Width Area .....	29
4.2 Central Area only .....	29
5 Lighting .....	31

5.1 Lighting(For GM861/GM861-LED)	31
5.2 Fill Lighting(For GM861-LED)	31
6 Prompts	32
6.1 Sound Prompts	32
6.1.1 Passive Buzzer	32
6.1.2 Active Buzzer	32
6.2 All Prompts Tone	33
6.3 Open Start-up Tone	33
6.4 Read Code Prompts Tone	33
6.4.1 Successfully Prompts Tone Setting	34
6.4.2 Read Successfully Prompts Tone	34
6.4.3 Duration Time Setting	34
6.5 Data Code Format	35
6.6 OUT1 Pin output	35
6.7 Keyboard Settlement	36
6.8 Virtual keyboard Allow	37
7 Data Edition	39
7.1 Prefix	39
7.2 AIM ID	40
7.3 CODE ID	40
7.4 Cut out Data	44
7.5 Suffix	46
7.6 Tail	46
7.7 RF Information	47
7.8 Output Protocol	48
8 Bar code type enables/disable configuration	49
8.1 All types of bar code can be decoded	49
8.2 Strengthen the Reading Ability	49
8.3 EAN13	49
8.3.1 EAN13	49
8.3.2 EAN13 Transfer Check Character	50
8.3.3 EAN13 Extra-code	50
8.3.4 EAN13 Output Mode	50
8.4 ISSN	51
8.4.1 ISSN	51
8.4.2 ISSN Extra-code	51
8.4.3 ISSN Output Mode	51
8.5 ISBN	52
8.5.1 ISBN	52
8.5.2 ISBN Extra-code	52
8.5.3 ISBN Output Mode	52
8.6 EAN8	53
8.6.1 EAN8	53
8.6.2 EAN8 Transfer Check Character	53

8.6.3 EAN8 Extra-code .....	53
8.6.4 EAN8 Output Mode .....	54
8.6.5 EAN-8 to EAN-13 .....	54
8.7 UPCA .....	54
8.7.1 UPCA .....	54
8.7.2 UPCA Transfer Check Character .....	54
8.7.3 UPCA Extra-code .....	55
8.7.4 UPCA Output Mode .....	55
8.7.5 UPC-A to EAN-13 .....	55
8.8 UPC-E .....	56
8.8.1 UPC-E0 .....	56
8.8.2 UPC-E1 .....	56
8.8.3 UPC-E Transfer Check Character(E0 and E1 take effect at the same time) .....	56
8.8.4 UPC-E Extra-code(E0 and E1 take effect at the same time) .....	56
8.8.5 UPC-E to UPC-A .....	57
8.9 Code128 .....	57
8.9.1 Code128 .....	57
8.9.2 Code128 Min Length of Reading .....	57
8.10 Code39 .....	58
8.10.1 Code39 .....	58
8.10.2 Code39 Min Length of Reading .....	58
8.10.3 Code39 Check Setting(Modulo 43) .....	58
8.10.4 Code39 Start/End Character Settings .....	59
8.10.5 Code39 Full ASCII .....	59
8.10.6 Code39 Pharmaceutical (PARAF) .....	60
8.11 Code93 .....	60
8.11.1 Code93 .....	60
8.11.2 Code93 Min Length of Reading .....	60
8.11.3 Code93 Check Setting .....	60
8.12 CodeBar .....	61
8.12.1 CodeBar .....	61
8.12.2 CodeBar Min Length of Reading .....	62
8.12.3 CodeBar Check Setting(Mod-16) .....	62
8.12.4 CodeBar Start/End Character Settings .....	63
8.13 Interleaved 2 of 5 .....	63
8.13.1 Interleaved 2 of 5 .....	63
8.13.2 Interleaved 2 of 5 Min Length of Reading .....	63
8.13.3 Interleaved 2 of 5 Check Setting(Mod-10) .....	64
8.14 ITF-14 .....	65
8.14.1 ITF-14 .....	65
8.15 ITF-6 .....	65
8.15.1 ITF-6 .....	65
8.16 Industrial 2 of 5 .....	65
8.16.1 Industrial 2 of 5 .....	65

8.16.2 Industrial 2 of 5 Min Length of Reading .....	66
8.16.3 Industrial 2 of 5 Check Setting(Mod-10) .....	66
8.17 Matrix 2 of 5 .....	67
8.17.1 Matrix 2 of 5 .....	67
8.17.2 Matrix 2 of 5 Min Length of Reading .....	67
8.17.3 Matrix 2 of 5 Check Setting(Mod-10) .....	67
8.18 Code 11 .....	68
8.18.1 Code 11 .....	68
8.18.2 Code 11 Min Length of Reading .....	68
8.18.3 Code 11 Check Setting .....	68
8.19 MSI-Plessey .....	69
8.19.1 MSI-Plessey .....	69
8.19.2 MSI-Plessey Min Length of Reading .....	69
8.19.3 MSI-Plessey Check Setting .....	69
8.19.4 MSI-Plessey Transfer check character .....	70
8.20 GS1-Databar (RSS) .....	70
8.20.1 RSS-14 .....	70
8.20.2 RSS-Limited .....	70
8.20.3 RSS-Expanded .....	71
8.20.4 RSS Min Length of Reading .....	71
8.21 GS1 Composite .....	71
8.21.1 GS1 Composite .....	71
8.21.2 GS1 Composite Min Length of Reading .....	72
8.22 Micro QR Code .....	72
8.22.1 Micro QR Code .....	72
8.23 QR Code .....	72
8.23.1 QR Code .....	72
8.24 Data Matrix .....	72
8.24.1 DM .....	72
8.24.2 DM Double Code Read .....	73
8.25 PDF417 .....	73
8.25.1 PDF417 .....	73
8.26 Micro PDF417 .....	74
8.26.1 Micro PDF417 .....	74
8.27 Aztec Code .....	74
8.27.1 Aztec Code .....	74
9 Image Control .....	75
9.1 Black and White Flip .....	75
10 Serial Port Instruction .....	76
10.1 CRC Algorithm .....	76
10.2 Read Zone Bit .....	77
10.3 Write Zone Bit .....	78
10.4 Save Zone Bit To Internal Flash Instruction .....	80
10.5 Zone Bit Reset To Defaults .....	81

10.6 List of zone bit .....	82
11 Appendix A: Common serial port instruction .....	92
12 Appendix B: Common serial port instruction .....	93
13 Appendix C: AIM ID .....	94
14 Appendix D: Code ID List .....	95
15 Appendix E: ASCII .....	96
16 Appendix F: Data code .....	100
17 Appendix G: Save or Cancel .....	102

# 1. Introduction of Module

## 1.1 Introduction

GM861/GM861-LED bar code reader module is a high performance scanner, can read 1D bar code easily and read 2D bar code with high speed. It also wins high scan speed for linear code, even for bar code on paper or screen.

GM861/GM861-LED bar code reader module is an advanced bar code decoding algorithm which developed on image recognition algorithm, can easily and accurately read bar code, simplify secondary development.

### 1.1.1 Read Version Information



Read Version Information

### 1.1.2 Read the Unique Device ID



Read the Unique Device ID

## 1.2 Technical Specification

Parameter	Performance
Sensor	CMOS
Scan Mode	640*480
GM861/GM861-LED Indicator Light	White light as power on Green light as read successfully
GM861-LED Fill Light	White light
Read Code Type	1D: EAN-13, EAN-8, UPC-A, UPC-E ISSN, ISBN, CodaBar, Code 128, Code93, ITF-14, ITF-6, Interleaved 2 of 5, Industrial 2 of 5, Matrix 2 of 5, Code 39, Code 11, MSI-Plessey, GS1 Composite, GS1-Databar (RSS)
	2D: QR Code, Data Matrix, PDF417, Micro QR, Micro PDF417, Aztec
GM861/GM861-LED Reading Distance	5-30cm
Contrast*	>25%
Scan Angle**	Roll: 360° Pitch: 65° Yaw: 65°
Viewing Angle	67° (Horizontal) 53° (Vertical)
Accuracy of reading*	≥10mil

\* Test conditions: environment temperature =23°C; environment illumination =300 LUX;

\*\* Test conditions: Test distance = (minimum depth of field + maximum depth of field) /2; environment temperature =23°C; environment illumination =300 LUX;

### Mechanical/electrical Parameters:

Parameter	Performance
Interface	TTL-232/USB
Size(mm)	External diameter: 28mm Internal diameter: 25mm Height: 15mm Thread M25
Weight	25 g
Prompting mode	LED Indicator
Operating Voltage	3.3V
Operation Current	70mA(Max)
Standby Current	≤6mA(Typical)
Startup time	≤250mS (Typical)

Environmental Parameters:

Parameter	Performance
Operating temperature	-20℃~+60℃
Storage Temperature	-40℃~+70℃
Operating Humidity	5%~95% (Non-Condensing)
Environmental Light	Normal indoor light source
Fall	Withstand 1.2 m drop on concrete floor (50 times 1.2 m drop on concrete floor repeatedly)

Default read configuration:

Type	Name	Support	Default Read
2D	QR Code	✓	✓
	Data Matrix	✓	✓
	PDF417	✓	✓
	Micro QR	✓	×
	Micro PDF417	✓	×
	Aztec	✓	×
1D	EAN-13	✓	✓
	EAN-8	✓	✓
	UPC-A	✓	✓
	UPC-E	✓	✓
	ISSN	✓	×
	ISBN	✓	×
	CodaBar	✓	×
	Code 128	✓	×
	Code93	✓	×
	ITF-14	✓	×
	ITF-6	✓	×
	Interleaved 2 of 5	✓	×
	Industrial 2 of 5	✓	×
	Matrix 2 of 5	✓	×
	GS1 Databar(RSS)	✓	×
	Code 39	✓	×
Code 11	✓	×	
MSI-Plessey	✓	×	

## **1.3 Electrical Characteristics**

### **1.3.1 Power Supply Requirements**

The power supply is DC +3.3V. The power input is allowed only after the GM861/GM861-LED is properly connected.

Electrical components of the GM861/GM861-LED may be damaged if you insert or remove the cable (with the electric plug) when the cable is live. Ensure that the power supply is switched off when you insert or remove the cable.

The GM861/GM861-LED may not work properly due to poor power connections, short power off/on intervals, or excessive voltage drop pulses. So pls keep the power is stable. After the power is turned off, the power must be turned on at least two seconds later.

### **1.3.2 Ripple noise**

Since the power input of GM861/GM861-LED is directly supplied to the image sensor and decoding chip.

To ensure stable operation, pls use low ripple noise power input.

It is recommended that the ripple noise not exceed 50mV (peak-to-peak).

## 1.4 Dimension(mm)&Pin Definition

### GM861 Dimension(mm)

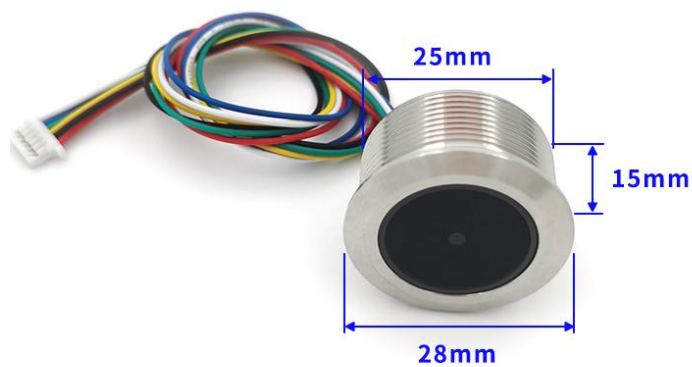

### GM861-LED Dimension(mm)



**GM861/GM861-LED Interface Definition (SH1.0mm 6pin)**

No.	Definition	Instruction
1	VCC	Power input 3.3V
2	TXD	Serial port send signal (TTL Level)
3	RXD	Serial port receiver signal (TTL Level)
4	GND	Signal ground
5	D-	USB data input
6	D+	USB data output



Note:

The line order has nothing to do with color.

## 1.5 Scan Area

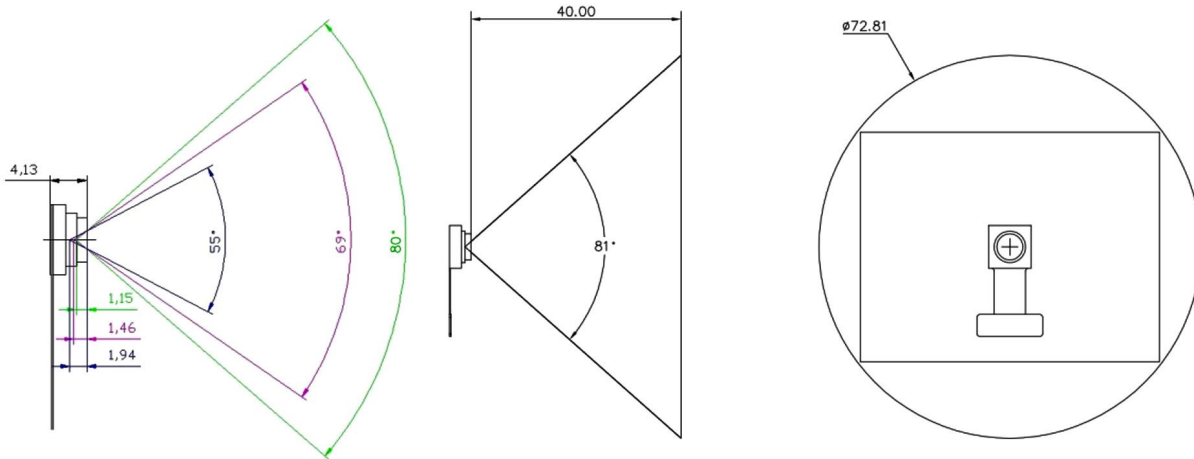

Reference design for lens opening:

The diagonal field Angle of the camera is  $80^\circ$  , so a certain allowance should be reserved during design.

As shown in Figure  $81^\circ$  , the light path cannot be blocked within this conical range;

Based on 5.2-inch mobile Phone Alipay QR code zero onset, bowl depth 40mm;

Pmma-4h or ultra white glass is recommended for window materials.

## 1.6 Setup Code

Customer can set module by scan setup code.



**Default: setup code on**

Output details in setup code



**Default: Not output**



**Off**



**Output**

Through the serial port, send the serial command to enable or disable the setting code function.

**If need enable setting code function:**

1. Send serial command: **\_SET\_CODE\_ON**
2. Then send save serial command to save: **7E 00 09 01 00 00 00 AB CD**

**If need disable setting code function:**

1. Send serial command: **\_SET\_CODE\_OFF**
2. Then send save serial command to save: **7E 00 09 01 00 00 00 AB CD**

## 1.7 Save and Cancel

Scan cancel code to cancel wrong read date.



Save



Cancel last byte



Cancel all read bytes



Cancel changes

## 1.8 Reset

Back to Factory Setting by scan follow code.



Reset

## 1.9 User Default Settings

In addition to factory settings, users also can save their frequently used configurations as default Settings. By scanning Save “Current Settings as User Default Settings”, users can save the current device configurations as default settings. If the module already has default user settings, the new configuration replaces the original default user settings.

By scanning "Restore the user default settings", the module can be switched to user default settings.



**Save Current Settings as User Default Settings**



**Restore the User Default Settings**

## 2 Communication interface

GM861/GM861-LED can receive database, control module and set functional parameter by TTL - 232.

### 2.1 Serial Communication Interface

It's default and common to connect module and mainframe(such as PC, POS) by serial communication interface. Make sure communication parameter for module and mainframe are same, then it will communicate smooth and correctly.



**Serial Output**

TTL-232 is used for serial interface which suitable for most system. Required change-over circuit for RS-232.

Default Parameter as form Form 2- 1. Only Baud Rate can be changed.

Form 2- 1 Default Parameters

Parameters	Default
Serial communication interface	Standard TTL-232
Baud rate	9600
Verification	N
Data bit	8
Stop bit	1
CTSRTS	N

#### Baud Rate Settlement



1200bps



4800bps



9600bps(Default)



14400bps



19200bps



38400bps



57600bps



115200bps

### 2.1.1 Serial Port Check Bit Configuration

Modify the parity bit of the serial port by scanning the following configuration code.



\*NONE



ODD



EVEN

### 2.1.2 Serial Port Calibration

Customers can periodically send heartbeat packets to ensure the data accuracy. The format is as follows:

Heartbeat packets from main control	Return command
7E 00 0A 01 00 00 00 30 1A	03 00 00 01 00 33 31

Note: It is recommended to send a heartbeat packet every 10 seconds. If no correct reply is received for three consecutive times, the main control should be handle it accordingly.

## 2.2 USB HID Interface

Scan the following code to become HID device when module connects PC by USB.



**\*USB HID device**

### 2.2.1 HID Type Device Selection

When the device is a HID type device, it can be 2 different types of devices.



**\*HIDKBW**



**HIDPOS**

### 2.2.2 HID Parameter Configuration

Scan the following code to modify the PC access cycle for HID devices.



**\*1ms**



**3ms**



**5ms**



**10ms**

Modify the interval between the device from a valid message to a released message by scanning the following setup code.



**\*0ms**



**1ms**



**5ms**



**10ms**



**15ms**

Modify the interval between the device from releasing message to the next valid message by scanning the following setup code.



**\*0ms**



**1ms**



**5ms**



**10ms**



**15ms**

Modify the state of the CapsLock when it prints by scanning the following setup code.



**\*Off**



**On**



**Compatible Mode**

**(7E 00 08 01 00 20 02 AB CD)**



**Case takes inverse output**



**Case normal output**



**All Upper Case**



**All Lower Case**

### **2.2.3 HID Lead Key Output**

By scanning the following setup code to make HID output a leading message before each segment of data, so as to facilitate customer software development and positioning. The key value is ctrl+shift+r.



**\*HID leading Forbid**



**Allow**

## 2.3 USB HID-KBW

### 2.3.1 HID-KBW Device Mode

If the device is an HID device (if it is not an HID device, pls read the configuration code of the HID device first),you can read the following configuration code and select HID-KBW device mode.

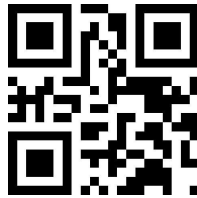

\*HID-KBW

### 2.3.2 HID-KBW Serial Output at the Same Time

By scanning the following setup code,while HID KBW is output, data is output through serial port.



\*Forbid



Allow

## 2.4 USB HID-POS

### 2.4.1 HID-POS Device Mode

If the device is an HID device (if it is not an HID device, pls read the configuration code of the HID device first),you can read the following configuration code and select HID-KBW device mode.



HID-POS

### 2.4.2 HID-POS HID-KBW Output at the Same Time

By scanning the following setup code to enable HIDKBW data output while HIDPOS output.



\*Forbid



Allow

### 2.5 USB Virtual Serial Port

Scan the following code to become virtual serial port output pattern when module connects PC by USB.



USB Virtual serial port

### 3 Read Mode

#### 3.1 Continuous Mode

On this mode, reading module read code continuous and automatic.

Break after reading one code, break time is changeable.

Click the toggle key to pause. Then click to continuous cyclic read code.



Default Continuous Mode

##### Time settlement for single read

The longest time before first successful reading. After this time, module will be into no read time.

Single Read time: 0.1~25.5 s, step-size: 0.1s;

0 means infinite time interval.

Default time: 5s



1000ms



\*5000ms



3000ms



infinite time interval

##### Break time settlement

Time between two read. Can be settled from 0 to 25.5 s, step-size: 0.1s; default 1.0s



No break



500ms



default 1000ms



1500ms



2000ms

**Same barcode reading delay**

The same barcode reading delay refers to that after the module reads the same bar code, it will be compared with the last reading time,when the interval is longer than the reading delay, the same barcode is allowed to be read, otherwise the output is not allowed.



Same barcode reading delay



\*Same bar code reading without delay

**Same barcode reading delay time**

When the same barcode reading delay is enabled,scan the following code to set same barcode reading delay time.



Infinite delay



500ms



\*1000ms



3000ms



5000m

**3.2 Induction Mode**

After setting, module begins to monitor brightness immediately. When scene changed, module will begin to read until time of image stabilization over.

After first successful reading or single reading time out, module will monitor brightness again after some time (changeable)

Module will cycle working as above when follow happen: module can't find code between single read time, then it will stop reading and jump to monitor brightness.

On induction mode, module can begin reading code by click, and it will begin to monitor brightness when release toggle key or successfully output information.



**Induction Mode**

**Time settlement for single read**

The longest time read before first successful reading. After this time, module will be into no read time.

Single Read time: 0.1~25.5 s, step-size: 0.1s;

0 means infinite time interval.

Default time: 5s



**1000ms**



**3000ms**



**Default 5000ms**



**infinite time interval**

**Break time settlement**

After one successful output or time out for single read. Module will be into monitor after some time.

Time from 0 to 25.5 s, step-size: 0.1s; default 1.0s



**No Break**



**500ms**



**Default 1000ms**



**1500ms**



**2000ms**

**Image stabilization time**

Image stabilization time: the time cost after module find scene change then waiting for the scene stable. Time from 0s to 25.5s, step size 0.1s. Default 0s.



\*0ms



100ms



400ms



1000ms



2000ms

**Sensitivity**

Detect the degree of change in the scene in inductive reading mode. When the reading module judges that the scene change degree meets the requirements, it will switch from the monitoring state to the reading state.



\*Ordinary sensitivity

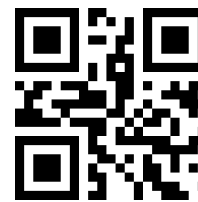

Low sensitivity



High sensitivity

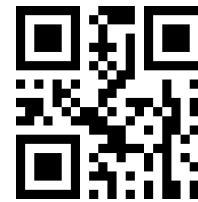

Extra high sensitivity

**Same barcode reading delay/Same barcode reading delay time**

The setup code is the same as in **Continuous Mode**.

**3.3 Manual Mode**

Manual mode is default mode. Click toggle key begin to read, stop when output or release toggle key



Manual Mode

### 3.3.1 Trigger Mode

Scan the following code to configuration edge trigger or level trigger.



\*Level Trigger



Edge Trigger

### 3.3.2 Sleep Mode Choice

In this mode, the module automatically enters sleep mode after being idle for a certain period of time by default. After entering sleep mode, you can press the key to wake up.

You can set the sleep mode using the following code (the deep sleep function cannot be enabled in USB communication mode).



Allow Sleep Mode



\*Forbid Sleep Mode

### 3.3.3 Idle Time For Sleep Mode

Scan the following configuration codes to set the idle time for sleep mode.



0ms



\*500ms



3000ms



5000ms



6000ms



7000ms

### 3.4 Command Triggered Mode

Module begins to read when receive scan command from mainframe( bit0 of zone bit 0x0002 writes"1" ) , and stop at output or read timeout.



Command triggered mode

Under command triggered mode, command for serial port trigger is 7E 00 08 01 00 02 01 AB CD;

After receiving command, model will output " 02 00 00 01 00 33 31" and start scan.

#### Time settlement for single read

Read and Scan time before output. From 0.1s to 25.5s, step size 0.1s. 0 : infinite time interval;  
Default: 5s



1000ms



3000ms



Default 5000ms



infinite time interval



200ms



300ms



400ms

### 3.5 POS Mode

Users can quickly configure the module to work in POS mode by scanning the following code. Including the following main features:

- Read mode is command trigger mode
- The communication interface is serial port
- Turn off startup tone
- Turn off ending character



POS Mode

## 4 Read area

### 4.1 Full Width Area

When the read area is a full-width area, the module will scan the barcode around with the center as the priority, and the barcode can be located at any position of the screen.



\*Full Width Area

### 4.2 Central Area only

When the reading area is the central area, the central position of the barcode must be in the central area set. Bar codes are not within the scope of the region are not identified and output.



Central Area only

Set the size of the central area:

The central area is an area with the center of the whole image as the central point. The size of this area is set in proportion to the width or height of the whole image, and the value range is 1-100. If set to 20, it is located in an area 20% of the width \* 20% of the height of the center.

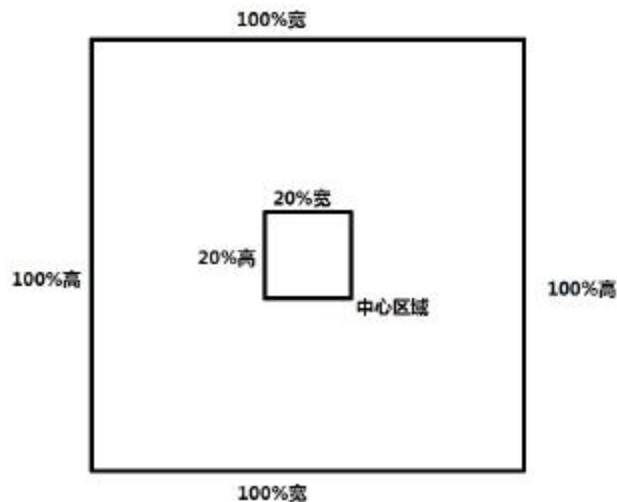

### Modify the central area size

The common central area size can be set by scanning the following code:



central area size-20%



central area size-40%



central area size-60%

When the common central area size does not meet the needs, users can also scan the "modify the central area size" setting code to customize the configuration.



modify the central area size

Example: change the center area size to 50%

1. Check the character table to get the hexadecimal value of "50" characters: "32"
2. Confirm whether the setting code is on or not. If it is off, please scan the "open setting code" setting code (see section 1.6).
3. Scan the setting code of "modify the size of central area"
4. Scan data setting codes "3" and "2" successively (see appendix F)
5. Scan "save" setting code (see appendix G)

## 5 Lighting

### 5.1 Lighting(For GM861/GM861-LED)

Head lamp is used to additional lighting when read.

Normal(default): Head lamp will be on when read, others off.

Normally on: always on after boot.

OFF: head lamp is always off



\*Normal



Normally on



Off

### 5.2 Fill Lighting(For GM861-LED)

Normal(default): Head lamp will be on when read, others off.

Normally on: always on after boot.

OFF: head lamp is always off



\*Normal



Normally on



Off

## 6 Prompts

### 6.1 Sound Prompts

#### 6.1.1 Passive Buzzer

Read "buzzer drive frequency", the buzzer can be set to active/passive buzzer, the drive frequency of the passive buzzer can also be set.



Buzzer drive frequency-passive high frequency



\*Buzzer drive frequency-passive medium frequency

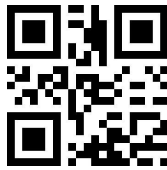

Buzzer drive frequency-passive low frequency

#### 6.1.2 Active Buzzer



Buzzer drive frequency - active drive

In the active buzzer mode, scan "Buzzer working level - high" can be set to low level when free, high level when busy; scan "Buzzer working level - low" can be set to high level when free, low level when busy.



\*Buzzer working level - high



Buzzer working level - low

## 6.2 All Prompts Tone

Silence: Close all prompt tones



Silence on



\*Silence off

## 6.3 Open Start-up Tone

Scan “Open Start-up tone” can open start-up tone. Scan “Close Start-up tone” can close start-up tone.



\*Open Start-up tone



Close Start-up tone

## 6.4 Read Code Prompts Tone

Read code prompt tone includes set the prompt tone and the read code successfully prompt tone:



\*Allow



Forbid

### 6.4.1 Successfully Prompts Tone Setting

In the state of "Allow Prompt Tone", you can scan the configuration code to enable or disable the setting success tone and reading success tone.



\*Open the setting success prompt tone



Close the setting success prompt tone

### 6.4.2 Read Successfully Prompts Tone



\*Open the reading success prompt tone



Close the reading success prompt tone

### 6.4.3 Duration Time Setting

Duration time setting. Default: 60ms



30ms



\*60ms



90ms



120ms

## 6.5 Data Code Format

Read following to enable the reading module to read the Chinese barcode of various encoding format.



**Input Data code format GBK**



**Input Data code format UTF8**



**\*Input Data code format AUTO**

Read following to print Chinese data according to specified code format.

GBK format: notepad, UTF8 format: WORD and input box for chat tools



**\*Output Data code format GBK**



**Output Data code format UTF8**



**Output Data code format RAW OUTPUT**

## 6.6 OUT1 Pin output

To make it easier for developers to develop applications in special environments, add OUT1 pin control

By default, the OUT1 pin is low level after power-on. It is controlled by serial port command, and the state is not saved after power-off.

Input: 7E 00 08 01 00 E7 00 AB CD    Output Low Level

Output: 02 00 00 01 00 33 31

Input: 7E 00 08 01 00 E7 01 AB CD    Output High Level

Output: 02 00 00 01 00 33 31

## 6.7 Keyboard Settlement

Scan following code to change keyboard.



Default Keyboard- US



Czech



France



Germany/Austria



Hungary



Italy



Japan



Spain



Turkey-F



Turkey-Q



Portugal



Brazil (Portuguese)



UK



Netherlands



Finland



Denmark



Poland



Sweden



Belgium (French)



Norway



Slovakia



Romania



Israel



Switzerland



Latin America (Spanish)



Russia



Canada (French)



Greece



Thailand

## 6.8 Virtual keyboard Allow

In order to be able to use in more areas, we also provide the virtual keyboard function, so that the virtual keyboard can be output in any keyboard mode, but it will relatively lose some output efficiency. In addition, when using a virtual keyboard, you must ensure that the numeric keys on the keypad are valid. Note that the virtual keyboard must be available at version 1.21 or above.



\*Standard keyboard



Virtual keyboard

In order to adapt to different application scenarios, the virtual keyboard has two different output modes for control characters smaller than 0x20, and the user can switch by scanning the following code.



**Ctrl Mode**



**\*Alt Mode**

## 7 Data Edition

Sometimes we need to edit the data before output to make data separation and processing more easily.

Data edition include:

- Add Prefix
- Output Identification Code AIM ID
- Output CodeID
- Add Suffix
- Cut data
- Add End words"Tail"

Output sequence after data edition:

【Prefix】 【AIM ID】 【CodeID】 【Data】 【Suffix】 【Tail】

### 7.1 Prefix

#### Add prefix

Prefix is on the head of encoding Information , and can be self-defined.

Scan the code to add prefix.



**Allow to add prefix**



**Default no prefix**

#### Change prefix

Scan "change prefix" and "setup code" code to change prefix.

Use 2 base 16 to express each character.

Max 15 characters.

ASCII on appendix E.



change prefix

**E.G. Change prefix to “DATA”**

1. "DTAT" in base 16: "44", "41", "54", "41"
2. Confirm open the " setup code", if not, find on 1.6
3. Scan "change prefix" code
4. Successively scan "Code ID": "4", "4", "4", "1", "5", "4", "4", "1"
5. Scan "save" code

**7.2 AIM ID**

AIM is Automatic Identification Manufacturers. AIM ID defines identification codes for various standard bar codes (users cannot customize AIM ID). For specific definitions, see Appendix C: AIM ID List. After decoding, the scanner can add this identification code to the bar code data, the format is "]" + letter" C "+ digit" 0 ". For example, the AIM ID of Code 128 is "]C0 ".

**Add AIM ID**

Users can identify different bar code types by AIM ID.

Users are not allowed to change the AIM ID which corresponding to each bar Code type. The Code ID is identified by three characters.



Allow Add AIM ID



\*Forbid Add AIM ID

**7.3 CODE ID**

**Add CODE ID**

Users can identify different types of bar code by CODE ID. CODE ID use one character to identify and can be self- defined.



**Allow add CODE ID**



**Default close CODE ID**

**Default of CODE ID**

Scan “ Default of CODE ID” to back default ID, default ID on appendix D



**\*all bar code back to default Code ID 0**



**all bar code back to default Code ID 1**



**all bar code back to default Code ID 2**

**Change CODE ID**

Users can change CODE ID of any bar code by scan the setup code (as follow) and data edition code.

Base 16 is used to express each CODE ID.

ASCII on appendix E.

**E.G.: change CODE ID of CODE 128 to “A”**

1. Find “A”=“41” in base 16
2. Confirm opening the “setup code”, if not, find on 1.6
3. Scan “ change CODE 128”
4. Successively scan “Code ID”: “4”, “1”
5. Scan “save” code

Change CODE ID LIST



Change CODE ID of EAN13



Change CODE ID of EAN8



Change CODE ID of UPCA



Change CODE ID of UPCE0



Change CODE ID of UPCE1



Change CODE ID of CODE 128



Change CODE ID of CODE 39



Change CODE ID of CODE 93



Change CODE ID of CODE BAR



Change CODE ID of Interleaved 2 of 5



Change CODE ID of Industrial 25



Change CODE ID of Matrix 2 of 5



Change CODE ID of CODE 11



Change CODE ID of MSI



Change CODE ID of RSS



Change CODE ID of limited RSS



Change CODE ID of expended RSS



Change CODE ID of QR CODE



Change CODE ID of Data Matrix



Change CODE ID of limited PDF417



Change CODE ID of MICROQR



Change CODE ID of AZTEC



Change CODE ID of MICROPDF417



Change CODE ID of ISBN



Change CODE ID of GS1STACK



Change CODE ID of ISSN

## 7.4 Cut out Data

Open to output part of data.

[Data] is composed of [Start] + [Center] + [End]

Character length of “start” and “end” can be changed



\*Output whole data



Output Start part



Output End Part



Output Center part

### Change length of [Start]-M

Scan “ Change M” code and “data edition” code to change length of [Start], max 255 characters

Base 16 is used to express length. ASCII on appendix E.



Change M

### Change length of [End]-N

Scan “ Change N” code and “data edition” code to change length of [Start], max 255 characters

Base 16 is used to express length. ASCII on appendix E.

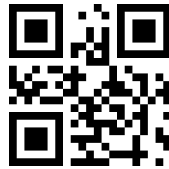

Change N

**Output Start part**

**E.G. Output “1234567890123” of whole decode information “ 1234567890123ABC”**

1. “13” =”0D” in base 16
2. Confirm opening the “setup code”, if not, find on 1.6
3. Scan” change length M”
4. Successively scan “Code ID”: “0”, “D”
5. Scan “save” code
6. Scan” Output Start part”

**Output End Part**

**E.G. Output “ABC” of whole decode information “ 1234567890123ABC”**

1. “3” = “03” in base 16
2. Confirm opening the “setup code” , if not, find on 1.6
3. Scan ”change length N”
4. Successively scan “Code ID”:.”0”, “3”
5. Scan “save” code
6. Scan” Output Start part”

**Output Center part**

**E.G.: Output “0123” of whole decode information “ 1234567890123ABC”**

1. “ 10” =”0A”; “3”=”03” in base16
2. Confirm opening the “setup code” , if not, find on 1.6
3. Scan “change length N”
4. Successively scan “Code ID”:.”0”, “3”
5. Scan “save” code
6. Scan ” change length M”
7. Successively scan :Code ID”: “0”, “A”
8. Scan “save” code
9. Scan “Output Center part”

## 7.5 Suffix

### Add Suffix

Suffix on the end of encoding Information, and can be self-defined.



**Allow add suffix**



**Default no suffix**

### Change suffix

Scan “ change suffix” and “setup code” code to change prefix.

Use base 16 to express each character.

Max 15 characters. ASCII on appendix E.



**Change Suffix**

### E.G.: Change suffix to “DATA”

1. “DTAT” in base 16: “44”, “41”, “54”, “41”
2. Confirm opening the “setup code”, if not, find on 1.6
3. Scan “change suffix” code
4. Successively scan “Code ID”: “4”, “4”, “4”, “1”, “5”, “4”, “4”, “1”
5. Scan “save” code

## 7.6 Tail

Open this function to help system quickly distinguish current decoding results.

Scan “Add tail” to open this function, if read success, there will be tail on the end of decode data.



**Close tail**



**\*Change tail to “CR”**



Change tail to "TAB"



Change tail to "CRLF"



Change tail to two "CRLF"

## 7.7 RF Information

RF(Read Fail): Users can self- define output information when read fail.



Output RF information



Default not output

### Change RF information

Scan "change RF information" and "data edition code" to change RF information.

Base 16 is used to express, max at 15 character. ASCII on appendix E.



Change RF information

#### E.G.: change RF to "FAIL"

1. Find "FAIL" in base-16: "46", "41", "49", "4C"
2. Confirm opening the "setup code", if not, find on 1.6
3. Scan " change RF information"
4. Successively scan "4" 、 "6" 、 "4" 、 "1" 、 "4" 、 "9" 、 "4" 、 "C"
5. Scan "save" code

## 7.8 Output Protocol

The output format of the decoded result can be modified in serial/virtual serial mode by scanning the following Settings code.

The format output with protocol is as follows: <03>< length >< decoded data >.

Note: The protocol mode must use UTF-8 data output format. In other output formats, only output the pure data even if the output with the protocol is selected.

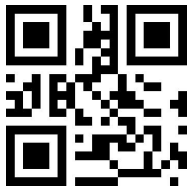

**\*Pure data**



**With the agreement**

## 8 Bar code type enables/disable configuration

### 8.1 All types of bar code can be decoded

After scan “ Forbid read all bar code” , module will only support to scan setup code.



Support all



Forbid read all bar code



\*Open default support types

### 8.2 Strengthen the Reading Ability

The bar code reading ability is enhanced through configuration, which will improve the reading Angle of all bar codes, improve the equipment's support for angles above 45° , and improve the contrast and gradient code support. Disabling Angle hardening will increase decoding speed.



\*Forbid to enhanced



Enhanced

### 8.3 EAN13

#### 8.3.1 EAN13



\*Allow reading EAN13



Forbid reading EAN13

### 8.3.2 EAN13 Transfer Check Character

EAN-13 bar code data is fixed at 13 bytes, and the last byte is the check character. Enable or disable the function of EAN-13 to transmit check characters by scanning the following setting codes.



**\*Allow**



**Forbid**

### 8.3.3 EAN13 Extra-code



**\* 2 bits extra-code Forbidden**



**2 bits extra-code Allow**



**\*5 bits extra-code Forbidden**



**5 bits extra-code Allow**

### 8.3.4 EAN13 Output Mode

Read the following setup code, which can be configured to output only if the extra-code is read, or to output without the extra-code is read.



**\*No need to read Extra-code, output directly**



**Have to read extra-code then have output**

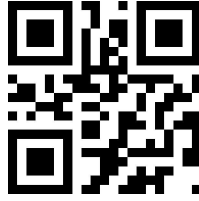

\*EAN-13 without Extra-code    Only read codes with Extra-code    Read with or without Extra-code

## 8.4 ISSN

### 8.4.1 ISSN



Allow reading ISSN



\*Forbid reading ISSN

### 8.4.2 ISSN Extra-code



\* 2 bits extra-code Forbidden



2 bits extra-code Allow



\* 5 bits extra-code Forbidden



5 bits extra-code Allow

### 8.4.3 ISSN Output Mode

Read the following setup code, which can be configured to output only if the extra-code is read, or to output without the extra-code is read.



\*No need to read Extra-code, output directly



Have to read extra-code then have output

## 8.5 ISBN

### 8.5.1 ISBN



Allow reading ISBN



\*Forbid reading ISBN

### 8.5.2 ISBN Extra-code



\*2 bits extra-code Forbidden



2 bits extra-code Allow



\*5 bits extra-code Forbidden



5 bits extra-code Allow

### 8.5.3 ISBN Output Mode

Read the following setup code, which can be configured to output only if the extra-code is read, or to output without the extra-code is read.



\*No need to read Extra-code, output directly



Have to read extra-code then have output

## 8.6 EAN8

### 8.6.1 EAN8



\*Allow reading EAN8



Forbid reading EAN8

### 8.6.2 EAN8 Transfer Check Character

EAN8 bar code data is fixed at 8 bytes, and the last byte is the check character. Enable or disable the function of EAN8 to transmit check characters by scanning the following setting codes.



\*Allow



Forbid

### 8.6.3 EAN8 Extra-code



\* 2 bits extra-code Forbidden



2 bits extra-code Allow



**\*5 bits extra-code Forbidden**



**5 bits extra-code Allow**

### 8.6.4 EAN8 Output Mode

Read the following setup code, which can be configured to output only if the extra-code is read, or to output without the extra-code is read.



**\*No need to read Extra-code, output directly**



**Have to read extra-code then have output**

### 8.6.5 EAN-8 to EAN-13



**Allow**



**\*Forbid**

## 8.7 UPCA

### 8.7.1 UPCA



**\*Allow reading UPCA**



**Forbid reading UPCA**

### 8.7.2 UPCA Transfer Check Character

UPCA bar code data is fixed at 13 bytes, and the last byte is the check character. Enable or disable the function of UPCA to transmit check characters by scanning the following setting codes.



**\*Allow**



**Forbid**

**8.7.3 UPCA Extra-code**



**\* 2 bits extra-code Forbidden**



**2 bits extra-code Allow**



**\*5 bits extra-code Forbidden**



**5 bits extra-code Allow**

**8.7.4 UPCA Output Mode**



**\*No Extra-code**



**Only read the code which have extra-code**

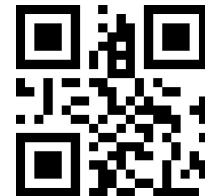

**All read**

**8.7.5 UPC-A to EAN-13**



**Allow**



**\*Forbid**

## 8.8 UPC-E

### 8.8.1 UPC-E0



**\*Allow reading UPCE0**



**Forbid reading UPCE0**

### 8.8.2 UPC-E1



**\*Allow reading UPCE1**

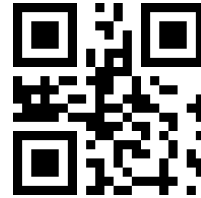

**Forbid reading UPCE1**

### 8.8.3 UPC-E Transfer Check Character(E0 and E1 take effect at the same time)

UPC-E bar code data is fixed at 8 bytes, and the last byte is the check character. Enable or disable the function of UPC-E to transmit check characters by scanning the following setting codes.



**\*Allow**



**Forbid**

### 8.8.4 UPC-E Extra-code(E0 and E1 take effect at the same time)



**\* 2 bits extra-code Forbidden**



**2 bits extra-code Allow**



**\*5 bits extra-code Forbidden**



**5 bits extra-code Allow**

Read the following setup code, which can be configured to output only if the extra-code is read, or to output without the extra-code is read.



**\*No need to read Extra-code, output directly**

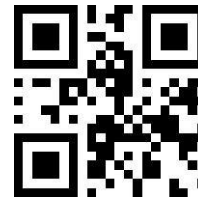

**Have to read extra-code then have output**

### 8.8.5 UPC-E to UPC-A



**Allow**



**\*Forbid**

## 8.9 Code128

### 8.9.1 Code128



**\*Allow reading Code128**



**Forbid reading Code128**

### 8.9.2 Code128 Min Length of Reading

Scan following code to change min length of code 128



Code128 min length at 0



\*Code128min length at 4

## 8.10 Code39

### 8.10.1 Code39



\*Allow reading Code39



Forbid reading Code39

### 8.10.2 Code39 Min Length of Reading

Scan following code to change min length of code39



Code39 min length at 0



\*Code39 min length at 4

### 8.10.3 Code39 Check Setting(Modulo 43)

Code 39 does not enforce the inclusion of a check character; if there is a check character, it must be the last byte of the data. The check character is the calculated value of all data except the check character, which is used to check whether the data is correct.

“Forbid Check”: the scanner will transfer all data

“Allow Check,no transfer check character”: the scanner will perform verification according to the last 1 bit of the barcode data. If the verification passes, it will be transmitted the normal data except the last digit of the check character. If the verification fails, the barcode content will not be sent.

“Allow Check,transfer check character”: the scanner will perform verification according to the last 1 bit of the barcode data. If the verification passes, the check character will be transfer the last 1 bit together. If the verification fails, the barcode content will not be sent.



**\*Forbid Check**



**Allow Check, no transfer check character**



**Allow Check, transfer check character**

When set to “Allow Check, no transfer check character”, if the data length is less than the minimum read length after deducting the 1 byte check character, the read will fail.

For example, the minimum read length of Code 39 is 4 bytes, and no transfer check characters, the attempt to read Code 39 with a total length of 4 bytes will fail.

### 8.10.4 Code39 Start/End Character Settings

Scan following code to change start character and end character output of code 39



**\*Start character No Output**



**Start character Output**



**\*End character No Output**



**End character Output**

### 8.10.5 Code39 Full ASCII



**\*Forbid FullAsc Mode****Allow FullAsc Mode**

### 8.10.6 Code39 Pharmaceutical (PARAF)

Code 32 Pharmaceutical is a form of Code 39 used in Italian pharmacies.

The bar code is also known as PARAF. The output format of Code 32 is: \* + A + 8-bit digits + 1-bit check + \*.

Code 32 Pharmaceutical can only be read if Code39 is enabled and no checksum.

**\*Forbid Code 32****Allow Code 32**

## 8.11 Code93

### 8.11.1 Code93

**\*Allow reading Code93****Forbid reading Code93**

### 8.11.2 Code93 Min Length of Reading

Scan following code to change min length of code93

**Code93 min length at 0****\*Code93 min length at 4**

### 8.11.3 Code93 Check Setting

Code 93 does not enforce the inclusion of a check character; if there is a check character, it must be

the last 2 bytes of the data. The check character is the calculated value of all data except the check character, which is used to check whether the data is correct.

“Forbid Check”: the scanner will transfer all data

“Allow Check,no transfer check character”: the scanner will perform verification according to the last 2 bit of the barcode data. If the verification passes, it will be transmitted the normal data except the last 2 digit of the check character. If the verification fails, the barcode content will not be sent.

“Allow Check,transfer check character”: the scanner will perform verification according to the last 2 bits of the barcode data. If the verification passes, the check character will be transfer the last 2 bits together. If the verification fails, the barcode content will not be sent.



**\*Forbid Check**



**Allow Check,no transfer check character**



**Allow Check,transfer check character**

When set to “Allow Check,no transfer check character”,if the data length is less than the minimum read length after deducting the 2 bytes check character, the read will be fails.

For example, the minimum read length of Code 93 is 4 bytes, and no transfer check characters, the attempt to read Code 93 with a total length of 4 bytes will fail.

## 8.12 CodeBar

### 8.12.1 CodeBar



**\*Allow reading CodeBar**



**Forbid reading CodeBar**

### 8.12.2 CodeBar Min Length of Reading

Scan following code to change min length of CodeBar



**CodeBar min length at 0**



**\*CodeBar min length at 4**

### 8.12.3 CodeBar Check Setting(Mod-16)

Codebar does not enforce the inclusion of a check character; if there is a check character, it must be the last byte of the data. The check character is the calculated value of all data except the check character, which is used to check whether the data is correct.

“Forbid Check”: the scanner will transfer all data

“Allow Check,no transfer check character”: the scanner will perform verification according to the last 1 bit of the barcode data. If the verification passes, it will be transmitted the normal data except the last digit of the check character. If the verification fails, the barcode content will not be sent.

“Allow Check,transfer check character”: the scanner will perform verification according to the last 1 bit of the barcode data. If the verification passes, the check character will be transfer the last 1 bit together. If the verification fails, the barcode content will not be sent.



**\*Forbid Check**



**Allow Check,no transfer check character**



**Allow Check,transfer check character**

When set to “Allow Check,no transfer check character”,if the data length is less than the minimum read length after deducting the 1 byte check character, the read will be fails.

For example, the minimum read length of Codebar is 4 bytes, and no transfer check characters, the attempt to read Codebar with a total length of 4 bytes will fail.

### 8.12.4 CodeBar Start/End Character Settings

There is a byte before and after the data as the start and end character, the start and end characters are one of the four characters "A", "B", "C", and "D",

You can set whether the start and end characters are transmitted together with the bar code data after read successful.

Scan following code to change start character and end character output of codebar.



**Send CodeBar Start Character**



**\*Don't send CodeBar Start Character**

### 8.13 Interleaved 2 of 5

#### 8.13.1 Interleaved 2 of 5



**Allow**



**\*Frobid**

#### 8.13.2 Interleaved 2 of 5 Min Length of Reading



**Interleaved 2 of 5 min length at 0**



**\*Interleaved 2 of 5 min length at 4**

### 8.13.3 Interleaved 2 of 5 Check Setting(Mod-10)

Interleaved 2 of 5 does not enforce the inclusion of a check character; if there is a check character, it must be the last byte of the data. The check character is the calculated value of all data except the check character, which is used to check whether the data is correct.

“Forbid Check”: the scanner will transfer all data

“Allow Check,no transfer check character”: the scanner will perform verification according to the last 1 bit of the barcode data. If the verification passes, it will be transmitted the normal data except the last digit of the check character. If the verification fails, the barcode content will not be sent.

“Allow Check,transfer check character”: the scanner will perform verification according to the last 1 bit of the barcode data. If the verification passes, the check character will be transfer the last 1 bit together. If the verification fails, the barcode content will not be sent.

Interleaved 2 of 5 code bits must be even and the check character is included in the code. If the code is odd, 0 will be added before the first bit. Check characters are automatically generated during code generation.



**\*Forbid Check**



**Allow Check,no transfer check character**



**Allow Check,transfer check character**

When set to “Allow Check,no transfer check character”,if the data length is less than the minimum read length after deducting the 1 byte check character, the read will be fails.

For example, the minimum read length of Interleaved 2 of 5 is 4 bytes, and no transfer check characters, the attempt to read Interleaved 2 of 5 with a total length of 4 bytes will fail.

## 8.14 ITF-14

ITF-14 is a specific format of Interleaved 2 of 5 bar code. The total length of its data is 14 bytes. The last byte is the check character.

### 8.14.1 ITF-14



Allow



\*Forbid

## 8.15 ITF-6

ITF-6 is similar to ITF-14. The fixed total length is 6 bytes.

### 8.15.1 ITF-6



Allow



\*Forbid

## 8.16 Industrial 2 of 5

### 8.16.1 Industrial 2 of 5



Allow



\*Forbid

### 8.16.2 Industrial 2 of 5 Min Length of Reading



**Industrial 2 of 5 min length at 0**

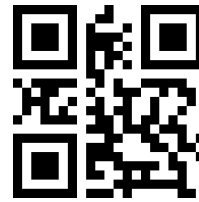

**\*Industrial 2 of 5 min length at 4**

### 8.16.3 Industrial 2 of 5 Check Setting(Mod-10)

Industrial 2 of 5 does not enforce the inclusion of a check character; if there is a check character, it must be the last byte of the data. The check character is the calculated value of all data except the check character, which is used to check whether the data is correct.

“Forbid Check”: the scanner will transfer all data

“Allow Check,no transfer check character”: the scanner will perform verification according to the last 1 bit of the barcode data. If the verification passes, it will be transmitted the normal data except the last digit of the check character. If the verification fails, the barcode content will not be sent.

“Allow Check,transfer check character”: the scanner will perform verification according to the last 1 bit of the barcode data. If the verification passes, the check character will be transfer the last 1 bit together. If the verification fails, the barcode content will not be sent.



**\*Forbid Check**



**Allow Check,no transfer check character**



**Allow Check,transfer check character**

When set to “Allow Check,no transfer check character”,if the data length is less than the minimum read length after deducting the 1 byte check character, the read will be fails.

For example, the minimum read length of Industrial 2 of 5 is 4 bytes, and no transfer check characters, the attempt to read Industrial 2 of 5 with a total length of 4 bytes will fail.

## 8.17 Matrix 2 of 5

### 8.17.1 Matrix 2 of 5



Allow



\*Forbid

### 8.17.2 Matrix 2 of 5 Min Length of Reading



Matrix 2 of 5 min length at 0



\*Matrix 2 of 5 min length at 4

### 8.17.3 Matrix 2 of 5 Check Setting(Mod-10)

Matrix 2 of 5 does not enforce the inclusion of a check character; if there is a check character, it must be the last byte of the data. The check character is the calculated value of all data except the check character, which is used to check whether the data is correct.

“Forbid Check”: the scanner will transfer all data

“Allow Check,no transfer check character”: the scanner will perform verification according to the last 1 bit of the barcode data. If the verification passes, it will be transmitted the normal data except the last digit of the check character. If the verification fails, the barcode content will not be sent.

“Allow Check,transfer check character”: the scanner will perform verification according to the last 1 bit of the barcode data. If the verification passes, the check character will be transfer the last 1 bit together. If the verification fails, the barcode content will not be sent.



\*Forbid Check



**Allow Check,no transfer check character**



**Allow Check,transfer check character**

When set to “Allow Check,no transfer check character”,if the data length is less than the minimum read length after deducting the 1 byte check character, the read will be fails.

For example, the minimum read length of Matrix 2 of 5 is 4 bytes, and no transfer check characters, the attempt to read Matrix 2 of 5 with a total length of 4 bytes will fail.

## 8.18 Code 11

### 8.18.1 Code 11



**Allow**



**\*Forbid**

### 8.18.2 Code 11 Min Length of Reading



**Code 11 min length at 0**



**\*Code 11 min length at 4**

### 8.18.3 Code 11 Check Setting

Code 11 does not enforce the inclusion of a check character; if there have check character, it must be the last byte of the data or last 2 byte of the data. The check character is the calculated value of all data except the check character, which is used to check whether the data is correct.

“Forbid Check”: the scanner will transfer all data



**\*Forbid Check**



**Allow Check, no transfer check character**



**Allow Check, transfer check character**

## 8.19 MSI-Plessey

### 8.19.1 MSI-Plessey



**Allow**



**\*Forbid**

### 8.19.2 MSI-Plessey Min Length of Reading

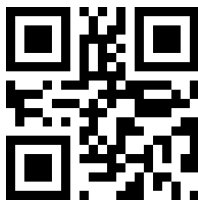

**MSI-Plessey min length at 0**



**\*MSI-Plessey min length at 4**

### 8.19.3 MSI-Plessey Check Setting

MSI-Plessey does not enforce the inclusion of a check character; if there have check character, it must be the last byte of the data or last 2 byte of the data. The check character is the calculated value of all data except the check character, which is used to check whether the data is correct.

“Forbid Check”: the scanner will transfer all data



**\*Forbid Check**



**MSI 1 bit check**



**MSI 2 bit check**

### 8.19.4 MSI-Plessey Transfer check character



**\*MSI Transfer Check Character**



**MSI NO Transfer Check Character**

When set to “Allow Check,no transfer check character”,if the data length is less than the minimum read length after deducting the 2 bytes check character, the read will be fails.

## 8.20 GS1-Databar (RSS)

### 8.20.1 RSS-14



**Allow**



**\*Forbid**

### 8.20.2 RSS-Limited



Allow



\*Forbid

### 8.20.3 RSS-Expanded



Allow



\*Forbid

### 8.20.4 RSS Min Length of Reading

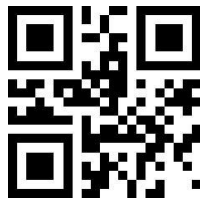

RSS min length at 0



\*RSS min length at 4

### 8.21 GS1 Composite

#### 8.21.1 GS1 Composite



Allow



\*Forbid

### 8.21.2 GS1 Composite Min Length of Reading



GS1 Composite min length at 0



\*GS1 Composite min length at 4

## 8.22 Micro QR Code

### 8.22.1 Micro QR Code



Allow



\*Forbid

## 8.23 QR Code

### 8.23.1 QR Code

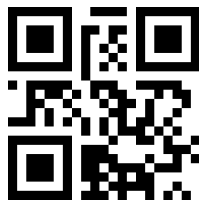

\*Allow



Forbid

## 8.24 Data Matrix

### 8.24.1 DM



**\*Allow**



**Forbid**

### 8.24.2 DM Double Code Read

Data Matrix double code: two Data Matrix bar codes arranged up and down or left and right. The direction of the double code should be consistent, the difference should be as small as possible, and the distance should be as close as possible. The two code setting is divided into the following three settings.

Only read single Data Matrix: The device only read one Data Matrix bar code at any time

Only read double Data Matrix: At any time, the device must detect the Data Matrix double code and send the decoding information only after both codes are decoded successfully. The sending sequence is from top to bottom or left to right.

Can read single and double DM codes: Readable single and double Data Matrix codes: check whether the Data Matrix double codes exist first when reading codes. If the Data Matrix double codes exist and are decoded successfully, the Data Matrix double codes will be sent; otherwise, the Data Matrix double codes will be processed as single codes.



**\*Only read single Data Matrix**



**Can read single and double DM codes**

## 8.25 PDF417

### 8.25.1 PDF417



**\*Allow**



**Forbid**

## 8.26 Micro PDF417

### 8.26.1 Micro PDF417



Allow



\*Forbid

## 8.27 Aztec Code

### 8.27.1 Aztec Code



Allow



\*Forbid

## 9 Image Control

### 9.1 Black and White Flip



\* One-dimensional barcode forbidden anti-color decoding



Allow



\* Two-dimensional barcode forbidden anti-color decoding



Allow

## 10 Serial Port Instruction

Users can settle the module by sending instruction from mainframe.

Please make sure communicate parameter complete matching between module and mainframe.

Module default serial communicate parameter: **Baud rate 9600bps; No check; 8 bit data; 1 bit stop bit; No flow control.**

### 10.1 CRC Algorithm

CRC: CRC\_CCITT check value (2 bytes).

Suitable for Types、Lens、Address、Datas;

Characteristic polynomial :  $X^{16}+X^{12}+X^5+1$ , multinomial coefficient: 0x1021, original value:0 ;

For single byte, the highest bit will be calculated at first, output will be without negation.

Reference code of C:

```

unsigned int crc_cal_by_bit(unsigned char* ptr, unsigned int len)
{
    unsigned int crc = 0;
    while(len-- != 0)
    {
        for(unsigned char i = 0x80; i != 0; i /= 2)
        {
            crc *= 2;
            if((crc&0x10000) != 0) //上一位 CRC 乘 2 后, 若首位是 1, 则除以 0x11021
                crc ^= 0x11021;
            if((*ptr&i) != 0) //如果本位是 1, 那么 CRC = 上一位的 CRC + 本位/CRC_CCITT
                crc ^= 0x1021;
        } // for(unsigned char i = 0x80; i != 0; i /= 2)
        ptr++;
    } // while(len-- != 0)
    return crc;
} // unsigned int crc_cal_by_bit(unsigned char* ptr, unsigned int len)

```

PS: when no need for checking CRC, CRC bite can be filled in 0xAB 0xCD

## 10.2 Read Zone Bit

Max 256 bytes/time for zone bit reading.

Command Format:

**Input: {Head1} {Types} {Lens} {Address} {Datas} {CRC}**

PS: Head1: 0x7E 0x00 (2 bytes)

Types: 0x07 (1 byte)

Lens: 0x01 (1 byte)

Address : 0x0000~0x00FF (2 bytes) , address to start reading zone bit

Datas: 0x00~0xFF (1 byte) , Numbers of zone bit for Sequential read, 0x00= 256bytes

CRC: CRC\_CCITT check value (2 bytes). Suitable for Types、Lens、Address、Datas;

Characteristic polynomial :  $X^{16}+X^{12}+X^5+1$ , multinomial coefficient: 0x1021, original value:0 ;

For single byte, the highest bit will be calculated at first, output will be without negation.

The reference code of C is as follows:

```

unsigned int crc_cal_by_bit(unsigned char* ptr, unsigned int len)
{
    unsigned int crc = 0;
    while(len-- != 0)
    {
        for(unsigned char i = 0x80; i != 0; i /= 2)
        {
            crc *= 2;
            if((crc&0x10000) != 0) //Last CRC * 2 , if the first one is 1, so divide 0x11021
                crc ^= 0x11021;
            if(*ptr&i != 0) //If the standard is 1, so CRC = last CRC + standard CRC_CCITT
                crc ^= 0x1021;
        } // for(unsigned char i = 0x80; i != 0; i /= 2)
        ptr++;
    } // while(len-- != 0)
    return crc;
} // unsigned int crc_cal_by_bit(unsigned char* ptr, unsigned int len)

```

Note: users can fill 0xAB 0xCD at CRC byte when CRC validation is not required.

**Output: {Head2} {Types} {Lens} {Datas} {CRC}**

1) Read successfully and return data

PS: Head2: 0x02 0x00 (2 bytes)

Types: 0x00 (read succeed) (1 byte)

Lens: numbers of upload bytes (1 byte) 0x00 means 256

Datas: 0x00~0xFF means read data.

CRC: CRC\_CCITT check value (2 bytes) . Suitable for Types、Lens、Datas;

Characteristic polynomial :  $X^{16}+X^{12}+X^5+1$ , multinomial coefficient: 0x1021, original value:0 ;

For single byte, the highest bit will be calculated at first, output will be without negation.

(The reference code is the same as above)

2) CRC failed

No response command

3) Unknown command response

No response command

**E.G.:**

Read address 0x000A of Zone bit

1) Read successfully and return data is 0x3E.

Input: 0x7E 0x00 0x07 0x01 0x00 0x0A 0x01 0xEE 0x8A

Output: 0x02 0x00 0x00 0x01 0x3E 0xE4 0xAC

2) CRC wrong

Input: 0x7E 0x00 0x07 0x01 0x00 0x0A 0x01 0x11 0x22

Output : None

3) When length of command to short or more than 400ms after 0x7e 0x00, treat as unknown command.

Input: 0x7E 0x00 0x07 0x01 0x00 0x0A 0x01

Output: None

### 10.3 Write Zone Bit

Max 256 bytes/time for zone bit reading.

**The modified content of the zone bit will be lost after power failure. If the modified content is needed after power loss, You need to save the zone bit to internal Flash(10.4).**

Command Format:

**Input: {Head1} {Types} {Lens} {Address} {Datas} {CRC}**

PS: Head1: 0x7E 0x00 (2 bytes)

Types: 0x08 (1 byte)

Lens: 0x00~0xFF ( 1 byte ) , means numbers of bytes of this datas, times of continuous writing.

Address: 0x0000~0xFFFF ( 2 bytes ) , start location of write

Datas: 0x00~0xFF ( 1~256 bytes ) , dates wrote in zone bit. When configuring multiple zone bit,must follow the order of address from low to high to fill the data domains.

CRC: CRC\_CCITT check value (2 bytes). Suitable for Types、Lens、Address、Datas;

Characteristic polynomial :  $X^{16}+X^{12}+X^5+1$ , multinomial coefficient: 0x1021, original value:0 ;

For single byte, the highest bit will be calculated at first, output will be without negation.

The reference code of C is as follows:

```

unsigned int crc_cal_by_bit(unsigned char* ptr, unsigned int len)
{
    unsigned int crc = 0;
    while(len-- != 0)
    {
        for(unsigned char i = 0x80; i != 0; i /= 2)
        {
            crc *= 2;
            if((crc&0x10000) != 0) //Last CRC * 2 , if the first one is 1, so divide 0x11021
                crc ^= 0x11021;
            if(*ptr&i) != 0 //If the standard is 1, so CRC = last CRC + standard CRC_CCITT
                crc ^= 0x11021;
        } // for(unsigned char i = 0x80; i != 0; i /= 2)
        ptr++;
    } // while(len-- != 0)
    return crc;
} // unsigned int crc_cal_by_bit(unsigned char* ptr, unsigned int len)

```

Note: users can fill 0xAB 0xCD at CRC byte when CRC validation is not required.

### Output: {Head2} {Types} {Lens} {Datas} {CRC}

#### 1) Read successfully

PS: Head2: 0x02 0x00 ( 2 bytes )

Types: 0x00 ( read succeed ) ( 1 byte )

Lens: 0x01 ( 1 byte )

Datas: 0x00 ( 1 byte )

CRC: CRC\_CCITT check value (0x33 0x31) ( 2 bytes )

#### 2) CRC failed

No response command

3) Unknown command response

No response command

**E.G.:**

Write 0x3E in 0x000A of zone bit

1) Successfully set

Input : 0x7E 0x00 0x08 0x01 0x00 0x0A 0x3E 0x4C 0xCF

Output: 0x02 0x00 0x00 0x01 0x00 0x33 0x31

2) CRC wrong

Input: 0x7E 0x00 0x08 0x01 0x00 0x0A 0x3E 0x11 0x22

Output: None

3) When length of command to short or more than 400ms after 0x7e 0x00, treat as unknown command.

Input: 0x7E 0x00 0x08 0x01 0x00 0x0A 0x3E

Output: None

## 10.4 Save Zone Bit To Internal Flash Instruction

To save the device of the zone bit list to internal Flash, you need to send a save command.

**Note:** the device cannot save a single zone bit configuration separately, and must keep the entire list at the same time.

Command Format:

**Input: {Head1} {Types} {Lens} {Address} {Datas} {CRC}**

PS: Head1: 0x7E 0x00 (2 bytes)

Types: 0x09 (1 byte)

Lens: 0x01 (1 byte)

Address: 0x0000 (2 bytes)

Datas: 0x00 (1 byte)

CRC: CRC\_CCITT check value (0xDE 0xC8) (2 bytes)

**Output: {Head2} {Types} {Lens} {Datas} {CRC}**

1) Saved successful

PS: Head2: 0x02 0x00 (2 bytes)

Types: 0x00 (read succeed) (1 byte)

Lens: 0x01 (1 byte)

Datas: 0x00 (1 byte)

CRC: CRC\_CCITT check value (0x33 0x31) (2 bytes)

2) CRC failed

No response command

3) Unknown command response

No response command

## 10.5 Zone Bit Reset To Defaults

Command Format:

**Input: {Head1} {Types} {Lens} {Address} {Datas} {CRC}**

PS: Head1: 0x7E 0x00 (2 bytes)

Types: 0x08 (1 byte)

Lens: 0x01 (1 byte)

Address: 0x00D9 (2 bytes)

Datas: 0x50 (1 byte)

CRC: CRC\_CCITT check value (81 D3) (2 bytes)

**Output: {Head2} {Types} {Lens} {Datas} {CRC}**

1) Saved successful

PS: Head2: 0x02 0x00 (2 bytes)

Types: 0x00 (read succeed) (1 byte)

Lens: 0x01 (1 byte)

Datas: 0x00 (1 byte)

CRC: CRC\_CCITT check value (0x33 0x31) (2 bytes)

2) CRC failed

No response command

3) Unknown command response

No response command

## 10.6 List of zone bit

Zone Bit	0x0000
Data Bit	Function
Bit 7	1: Open LED when successfully read 0: Close
Bit 6	1: Mute off 0: Mute on
Bit 5-4	00: No light 01: Standard 10/11: Always on
Bit 3-2	00: No light 01: Standard 10/11: Always on
Bit 1-0	00: Manual Mode 01: Command Triggered Mode 10: Continuous mode 11: Induction Mode
Zone Bit	0x0002
Data Bit	Function
Bit 7-1	Keep
Bit 0	Command mode triggers flags, Automatically reset after scanning 1: trigger 0: no trigger
Zone Bit	0x0003
Data Bit	Function
Bit 7-2	HID query cycle. Cycle = (Reg0x0003[7:2]+1) ms
Bit 1	1: Close Settlement Code 0: Open
Bit0	1: Output content of settlement code 0: Not output
Zone Bit	0x0004
Data Bit	Function
Bit 7-0	The time of Image stabilization 0x00-0xFF: 0.0-25.5s
Zone Bit	0x0005
Data Bit	Function
Bit 7-0	Read interval 0x00: No interval 0x01-0xFF: 0.0-25.5s
Zone Bit	0x0006
Data Bit	Function
Bit 7-0	Time for single read 0x01-0xFF: 0.0-25.5s
Zone Bit	0x0009
Data Bit	Function
Bit7-2	HID the interval before release Interval = (Reg0x0009[7:2]) ms
Bit 1-0	Image rollovers 00: Forbid 01: Allow 10/11: Keep
Zone Bit	0x000A
Data Bit	Function
Bit7-0	Keep
Zone Bit	0x000B
Data Bit	Function

Bit7-0	Keep
Zone Bit	0x000C
Data Bit	Function
Bit 7-2	HID the interval after release Interval = (Reg0x000C[7:2]) ms
Bit1	CapsLock Switch 0: On 1: Off
Bit0	Keep
Zone Bit	0x000D
Data Bit	Function
Bit 7	0
Bit 6	Virtual keyboard enable flags 0: Forbid 1: Allow
Bit5-4	Input data encoding format 00: GBK 01: Keep 10: AUTO 11: UTF8
Bit 3-2	Output data encoding format 00: GBK 01: UNICODE 10: Keep 11: UTF8
Bit1-0	00: serial port output 01: USB PC Keyboard 10: Keep 11: USB virtual serial port
Zone Bit	0x000E
Data Bit	Function
Bit7-4	Sleep free time Free time= (Reg0x000E[7:4]*500) ms
Bit3	Keep
Bit2	Keep
Bit1	Keep
Bit0	1: Allow serial port mode HID protocol 0: Forbid
Zone Bit	0x000F
Data Bit	Function
Bit7-0	Sensitivity adjustment parameter 1 0x00-0xFF: higher value, lower sensitivity, default value 0x32
Zone Bit	0x0010
Data Bit	Function
Bit7-0	Sensitivity adjustment parameter 2 0x00-0xFF: higher value, lower sensitivity, default value 0x0A
Zone Bit	0x0013
Data Bit	Function
Bit 7	Same barcode reading delay setting 0: Turn off 1: Turn on
Bit 6-0	Same barcode reading delay time (Unit: 100ms) 0x00: Infinite length 0x01-0x7F: 0.1-12.7s;
Zone Bit	0x0014
Data Bit	Function
Bit 7-0	Reserved time for information output (Unit: 10ms) 0x00-0xFF: 0-2.55 s
Zone Bit	0x0026

Data Bit	Function
Bit7-1	Keep
Bit 0	Read RSS_STACK 0: Forbid 1: Allow
Zone Bit	0x0029
Data Bit	Function
Bit7-1	Keep
Bit 0	Read MICROPDF417 0: Forbid 1: Allow
Zone Bit	0x002B, 0x002A
Data Bit	Function
Bit 15	Keep
Bit 14-13	Parity Mode: 0: None 1: Odd 2: Even
Bit 12-0	0x09C4: Serial rate 1200 bps 0x0271: Serial rate 4800 bps 0x0139: Serial rate 9600 bps 0x00D0: Serial rate14400 bps 0x009C: Serial rate19200 bps 0x004E: Serial rate 38400 bps 0x0034: Serial rate 57600 bps 0x001A: Serial rate 115200bps E.G.: 9600 Baud rate: 0x002A = 0x39 , 0x002B = 0x01
Zone Bit	0x002C
Data Bit	Function
Bit 7-4	Keep
Bit3	Decoding range setting 0: Full Width 1: the central area only
Bit 2-1	Bar code switch 00: forbid reading all bar code 01: all bar code can be read; 11: Default 10: Keep
Bit 0	Keep
Zone Bit	0x002D
Data Bit	Function
Bit 7-0	Center area range setting 0x01-0x64: 1%-100% Other values: 50%
Zone Bit	0x002E
Data Bit	Function
Bit 7-1	Keep
Bit0	Read EAN13 0: Forbid 1: Allow
Zone Bit	0x002F

Data Bit	Function
Bit 7-1	Keep
Bit0	Read EAN8 0: Forbid 1: Allow
Zone Bit	0x0030
Data Bit	Function
Bit 7-1	Keep
Bit0	Read UPCA 0: Forbid 1: Allow
Zone Bit	0x0031
Data Bit	Function
Bit 7-1	Keep
Bit0	Read UPCE0 0: Forbid 1: Allow
Zone Bit	0x0032
Data Bit	Function
Bit 7-1	Keep
Bit0	Read UPCE1 0: Forbid 1: Allow
Zone Bit	0x0033
Data Bit	Function
Bit 7-1	Keep
Bit0	Read Code128 0: Forbid 1: Allow
Zone Bit	0x0034
Data Bit	Function
Bit 7-0	Code128 Information minimum length setting 0x00-0xFF: 0-255Byte
Zone Bit	0x0035
Data Bit	Function
Bit 7-0	Code128 Information maximum length setting 0x00-0xFF: 0-255Byte
Zone Bit	0x0036
Data Bit	Function
Bit 7-1	Keep
Bit0	Read Code39 0: Forbid 1: Allow
Zone Bit	0x0037
Data Bit	Function
Bit 7-0	Code39 Information minimum length setting 0x00-0xFF: 0-255Byte
Zone Bit	0x0038

Data Bit	Function
Bit 7-0	Code39 Information maximum length setting 0x00-0xFF: 0-255Byte
Zone Bit	0x0039
Data Bit	Function
Bit 7-1	Keep
Bit0	Read Code93 0: Forbid      1: Allow
Zone Bit	0x003A
Data Bit	Function
Bit 7-0	Code93 Information minimum length setting 0x00-0xFF: 0-255Byte
Zone Bit	0x003B
Data Bit	Function
Bit 7-0	Code93 Information maximum length setting 0x00-0xFF: 0-255Byte
Zone Bit	0x003C
Data Bit	Function
Bit 7-2	Keep
Bit1	CodeBar code send the start/end character 0: Forbid      1: Allow
Bit0	Read CodeBar 0: Forbid      1: Allow
Zone Bit	0x003D
Data Bit	Function
Bit 7-0	CodeBar Information minimum length setting 0x00-0xFF: 0-255Byte
Zone Bit	0x003E
Data Bit	Function
Bit 7-0	CodeBar Information maximum length setting 0x00-0xFF: 0-255Byte
Zone Bit	0x003F
Data Bit	Function
Bit 7-1	Keep
Bit0	Read QR 0: forbid      1: allow
Zone Bit	0x0040
Data Bit	Function
Bit 7-1	Keep
Bit0	Read Interleaved 2 of 5 0: forbid      1: allow
Zone Bit	0x0041

Data Bit	Function
Bit 7-0	Interleaved 2 of 5 Information minimum length setting 0x00-0xFF: 0-255Byte
Zone Bit	0x0042
Data Bit	Function
Bit 7-0	Interleaved 2 of 5 Information maximum length setting 0x00-0xFF: 0-255Byte
Zone Bit	0x0043
Data Bit	Function
Bit 7-1	Keep
Bit0	Read Industrial 25 0: forbid            1: allow
Zone Bit	0x0044
Data Bit	Function
Bit 7-0	Industrial 25 Information minimum length setting 0x00-0xFF: 0-255Byte
Zone Bit	0x0045
Data Bit	Function
Bit 7-0	Industrial 25 Information maximum length setting 0x00-0xFF: 0-255Byte
Zone Bit	0x0046
Data Bit	Function
Bit 7-1	Keep
Bit0	Read Matrix 2 of 5 0: forbid            1: allow
Zone Bit	0x0047
Data Bit	Function
Bit 7-0	Matrix 2 of 5 Information minimum length setting 0x00-0xFF: 0-255Byte
Zone Bit	0x0048
Data Bit	Function
Bit 7-0	Matrix 2 of 5 Information maximum length setting 0x00-0xFF: 0-255Byte
Zone Bit	0x0049
Data Bit	Function
Bit 7-1	Keep
Bit0	Read Code11 0: forbid            1: allow
Zone Bit	0x004A
Data Bit	Function
Bit 7-0	Code11 Information minimum length setting 0x00-0xFF: 0-255Byte

Zone Bit	0x004B
Data Bit	Function
Bit 7-0	Code11 Information maximum length setting 0x00-0xFF: 0-255Byte
Zone Bit	0x004C
Data Bit	Function
Bit 7-1	Keep
Bit0	Read MSI 0: forbid          1: allow
Zone Bit	0x004D
Data Bit	Function
Bit 7-0	MSI Information minimum length setting 0x00-0xFF: 0-255Byte
Zone Bit	0x004E
Data Bit	Function
Bit 7-0	MSI Information maximum length setting 0x00-0xFF: 0-255Byte
Zone Bit	0x004F
Data Bit	Function
Bit 7-1	Keep
Bit0	Read RSS-14 0: forbid          1: allow
Zone Bit	0x0050
Data Bit	Function
Bit 7-1	Keep
Bit0	Read limited RSS 0: forbid          1: allow
Zone Bit	0x0051
Data Bit	Function
Bit 7-1	Keep
Bit0	Read Expended RSS 0: forbid          1: allow
Zone Bit	0x0052
Data Bit	Function
Bit 7-0	RSS Information minimum length setting 0x00-0xFF: 0-255Byte
Zone Bit	0x0053
Data Bit	Function
Bit 7-0	RSS Information maximum length setting 0x00-0xFF: 0-255Byte
Zone Bit	0x0054
Data Bit	Function

Bit 7-1	Keep
Bit1	Read Double Code DM 0: forbid      1: allow
Bit0	Read DM 0: forbid      1: allow
Zone Bit	0x0055
Data Bit	Function
Bit 7-1	Keep
Bit0	Read PDF17 0: forbid      1: allow
Zone Bit	0x0056
Data Bit	Function
Bit 7-1	Keep
Bit0	Read ISSN 0: forbid      1: allow
Zone Bit	0x0057
Data Bit	Function
Bit 7-1	Keep
Bit0	Read ISBN 0: forbid      1: allow
Zone Bit	0x005C
Data Bit	Function
Bit0	Read AZTEC 0: forbid      1: allow
Zone Bit	0x005F
Data Bit	Function
Bit 7-1	Keep
Bit0	Read MICROQR 0: forbid      1: allow
Zone Bit	0x0060
Data Bit	Function
Bit 7	Serial/virtual serial output with or without protocol 0: Original data      1: With protocol
Bit6-5	Type of Tailed 00: CR(0x0D)      01: CRLF(0x0D,0x0A) 10: TAB(0x09)      11: None
Bit4	1: Allow add RF      0: forbid
Bit3	1: Allow add prefix      0: forbid
Bit2	1: Allow add Code ID      0: forbid
Bit1	1: Allow add suffix      0: forbid
Bit0	1: Allow add tail      0: forbid
Zone Bit	0x0100

Data Bit	Function
Bit 7-4	Keep
Bit 3-0	Length of prefix 0x00-0x0F
Zone Bit	00x0101- 0x010F
Data Bit	Function
Bit 7-0	Prefix 0x00-0xFF: Prefix content,max 15Byte
Zone Bit	0x0110
Data Bit	Function
Bit 7-4	Keep
Bit 3-0	Length of suffix 0x00-0x0F
Zone Bit	0x0111- 0x011F
Data Bit	Function
Bit 7-0	Suffix 0x00-0xFF: Suffix content,max 15Byte
Zone Bit	0x0700
Data Bit	Function
Bit 7-4	Keep
Bit 3-0	RF length 0x00-0x0F
Zone Bit	0x0701-0x070F
Data Bit	Function
Bit 7-0	RF Data 0x00-0x0F,max 15Byte
Zone Bit	0x0061
Data Bit	Function
Bit 7-0	Keyboard Settlement 00: US 01: Czech 02: France 03: Germany 04: Hungary 05: Italy 06: Japan 07: Spain 08: Turkey Q 09: Turkey F 0A: Portugal 0B: Brazil 0C: UK 0D: Netherlands 0E: Finland 0F: Denmark 10: Poland 11: Sweden 12: Belgium 13: Norway 14: Slovakia 15: Romania 16: Israel 17: Switzerland 18: Latin America 19: Russian 1A: Canada 1B: Greece 1C: Thai
Zone Bit	0x00B0
Data Bit	Function
Bit 7-2	Keep
Bit 1-0	Data Cut out settlement 00: Output whole data 01: Output Start part 10: Output End part 11: Output center part

Zone Bit	0x00B1
Data Bit	Function
Bit 7-0	Cut out M bytes from start 0x00-0xFF: 0-255 Byte
Zone Bit	0x00B2
Data Bit	Function
Bit 7-0	Cut out N bytes from end 0x00-0xFF: 0-255 Byte
Zone Bit	0x00D9 (Only read Zone bit)
Data Bit	Function
Bit 7-0	Function Zone bit 0x50: reset to defaults 0x55: Restore user-defined factory settings 0x56: The current settings are saved as user-defined factory settings 0xA5: Deep sleep, can be awakened by serial port interrupt, this serial port command is invalid 0x00: You can write 0 to wake up the device from sleep

## 11 Appendix A: Common serial port instruction

Parameter		Default Setting		Note
Communication interface				
TTL-232	Baud rate	9600		
	Verification	No		
	Bata Bit	8 bit		
	Stop Bit	1 bit		
	CTSRTS	No		
Mode Parameter				
Default Read Mode			Continuous Mode	
Serial mode	Read code time for once	5s	Parameter:0.1-25.5s; step-size: 0.1s; 0 means no time limited	

## 12 Appendix B: Common serial port instruction

Function	Instruction
Baud rate to 9600	7E 00 08 02 00 2A 39 01 A7 EA
Save settlements to Internal Flash	7E 00 09 01 00 00 00 DE C8
Find baud rate	7E 00 07 01 00 2A 02 D8 0F
LED on + Mute off+Normal lighting +Normal brightness+Continuous mode	7E 00 08 01 00 00 D6 AB CD
Trigger mode	7E 00 08 01 00 02 01 AB CD
Full area + allow read all bar codes	7E 00 08 01 00 2C 02 AB CD
Allow read Code39	7E 00 08 01 00 36 01 AB CD
Code39 Min length	7E 00 08 01 00 37 00 AB CD
Code39 Max length	7E 00 08 01 00 38 FF AB CD
Allow to add suffix	7E 00 08 01 00 60 03 AB CD
Modify the suffix command 7E 00 08 (N+1) 01 10 (N) (N byte suffixes) AB CD Example (Add a four-byte suffix "DATA")	7E 00 08 05 01 10 04 44 41 54 41 AB CD
Cut out data:Output Start part	7E 00 08 01 00 B0 01 AB CD
Cut out M bytes from start	7E 00 08 01 00 B1 FF AB CD
Output End part	7E 00 08 01 00 B0 02 AB CD
Cut out N bytes from end	7E 00 08 01 00 B2 FF AB CD
Output center part	7E 00 08 01 00 B0 03 AB CD
Cut out M bytes from start (Eg: three characters)	7E 00 08 01 00 B1 03 AB CD
Cut out N bytes from end (Eg: two characters)	7E 00 08 01 00 B2 02 AB CD
OUT1 Output low level	7E 00 08 01 00 E7 00 AB CD
OUT1 Output high level	7E 00 08 01 00 E7 01 AB CD
Allow AIM ID	7E 00 08 01 00 D0 80 AB CD
Forbid AIM ID	7E 00 08 01 00 D0 00 AB CD

Module will return following info after mainframe send serial port instruction - find baud rate

Return information	Baud rate
02 00 00 02 C4 09 SS SS	1200
02 00 00 02 71 02 SS SS	4800
02 00 00 02 39 01 SS SS	9600
02 00 00 02 D0 00 SS SS	14400
02 00 00 02 9C 00 SS SS	19200
02 00 00 02 4E 00 SS SS	38400
02 00 00 02 34 00 SS SS	57600

PS: SS SS= check value

## 13 Appendix C: AIM ID

Code Type	AIM ID	Instruction
Code 128	JC0	Code 128
EAN-8	JE4	EAN-8
EAN-13	JE0	EAN-13
ISSN	JX5	
ISBN	JX4	
UPC-E	JE0	UPC-E
UPC-A	JE0	UPC-A
Interleaved 2 of 5	JJ0	No parity
ITF-6	JJ1	Output check character
ITF-14	JJ1	Output check character
Matrix 2 of 5	JX1	No parity
Industrial 25	JS0	No specific designation now
Standard 25	JR0	No parity
China Post 25	JX0	
Code 39	JA1	MOD 43 check, Output check character
Codabar	JF0	Standard data packet
Code 93	JG0	No specific designation now
Code11	JH1	MOD11/MOD11 double check, Output check character
MSI Plessey	JM1	MOD10 check, but no output check character
GS1 Composite	Jem	(0~3), possible AIM ID qualifying parameter (m)
GS1 Databar (RSS)	Je0	RSS-14, RSS-Limited, RSS-Expanded, RSS-Stacked
PDF417	JL0	Conform to 1994 PDF417
Data Matrix	Jd1	DM code ECC 200
QR Code	JQ1	QR code mode 2( 2005 symbol), The ECI protocol is not used
Micro PDF417	JL0	
Micro QR	JQ1	
Aztec Code	Jzm	(0-9, A-C), Possible AIM ID qualifying parameter (m)

Reference: ISO/IEC 15424-2008 Information technology -- Automatic identification and data acquisition techniques -- Data carrier identifiers (including symbol identifiers)

## 14 Appendix D: Code ID List

Code Type	Code ID 0(Default)	Code ID 1	Code ID 2
Code 128	j (0x6A)	B (0x42)	j (0x6A)
EAN-8	d (0x64)	D (0x44)	D (0x44)
EAN-13	d (0x64)	E (0x45)	d (0x64)
ISSN	n (0x6E)	_ (0x5F)	<i>d</i> (0x64)
ISBN	B (0x42)	W (0x57)	<i>d</i> (0x64)
UPC-E	c (0x63)	F (0x46)	E (0x45)
UPC-A	c (0x63)	G (0x47)	c (0x63)
Interleaved 2 of 5	e (0x65)	H (0x48)	e (0x65)
ITF-6	e (0x65)	I (0x49)	<i>e</i> (0x65)
ITF-14	e (0x65)	J (0x4A)	<i>e</i> (0x65)
Matrix 2 of 5	v (0x76)	Y (0x59)	m (0x6D)
Industrial 2 of 5	l (0x49)	X (0x58)	f (0x66)
Standard 2 of 5	f (0x66)	P (0x50)	<i>f</i> (0x66)
Code 39 (supports Full ASCII mode)	b (0x62)	M (0x4D)	b (0x62)
Codabar	a (0x61)	O (0x4F)	a (0x61)
Code 93	i (0x69)	Q (0x51)	i (0x69)
Code 11	H (0x48)	] (0x5D)	h (0x68)
MSI Plessey	m (0x6D)	V (0x56)	g (0x67)
GS1 DataBar	R (0x52)	Z (0x5A)	y (0x79)
GS1 DataBar Limited	R (0x52)	[ (0x5B)	{ (0x7B)
GS1 DataBar Expanded	R (0x52)	\ (0x5C)	} (0x7D)
GS1 Composite	y (0x79)	<i>y</i> (0x79)	y (0x79)
PDF417	r (0x72)	` (0x60)	r (0x72)
Data Matrix	u (0x75)	c (0x63)	w (0x77)
QR Code	s (0x73)	a (0x61)	s (0x73)
Aztec Code	z (0x7A)	<i>z</i> (0x7A)	z (0x7A)
Maxicode	x (0x78)	<i>x</i> (0x78)	x (0x78)
Micro PDF417	R (0x52)	<i>R</i> (0x52)	R (0x52)
Micro QR	X (0x58)	<i>X</i> (0x58)	s (0x73)

## 15 Appendix E: ASCII

Hexadecimal	Decimalism	Character
00	0	NUL (Null char.)
01	1	SOH (Start of Header)
02	2	STX (Start of Text)
03	3	ETX (End of Text)
04	4	EOT (End of Transmission)
05	5	ENQ (Enquiry)
06	6	ACK (Acknowledgment)
07	7	BEL (Bell)
08	8	BS (Backspace)
09	9	HT (Horizontal Tab)
0a	10	LF (Line Feed)
0b	11	VT (Vertical Tab)
0c	12	FF (Form Feed)
0d	13	CR (Carriage Return)
0e	14	SO (Shift Out)
0f	15	SI (Shift In)
10	16	DLE (Data Link Escape)
11	17	DC1 (XON) (Device Control 1)
12	18	DC2 (Device Control 2)
13	19	DC3 (XOFF) (Device Control 3)
14	20	DC4 (Device Control 4)
15	21	NAK (Negative Acknowledgment)
16	22	SYN (Synchronous Idle)
17	23	ETB (End of Trans. Block)
18	24	CAN (Cancel)
19	25	EM (End of Medium)
1a	26	SUB (Substitute)
1b	27	ESC (Escape)
1c	28	FS (File Separator)
1d	29	GS (Group Separator)
1e	30	RS (Request to Send)
1f	31	US (Unit Separator)

20	32	SP (Space)
21	33	! (Exclamation Mark)
22	34	" (Double Quote)
23	35	# (Number Sign)
24	36	\$ (Dollar Sign)
25	37	% (Percent)
26	38	& (Ampersand)
27	39	` (Single Quote)
28	40	( (Right / Closing Parenthesis)
29	41	) (Right / Closing Parenthesis)
2a	42	* (Asterisk)
2b	43	+ (Plus)
2c	44	, (Comma)
2d	45	- (Minus / Dash)
2e	46	. (Dot)
2f	47	/ (Forward Slash)
30	48	0
31	49	1
32	50	2
33	51	3
34	52	4
35	53	5
36	54	6
37	55	7
38	56	8
39	57	9
3a	58	: (Colon)
3b	59	; (Semi-colon)
3c	60	< (Less Than)
3d	61	= (Equal Sign)
3e	62	> (Greater Than)
3f	63	? (Question Mark)
40	64	@ (AT Symbol)
41	65	A
42	66	B
43	67	C
44	68	D

45	69	E
46	70	F
47	71	G
48	72	H
49	73	I
4a	74	J
4b	75	K
4c	76	L
4d	77	M
4e	78	N
4f	79	O
50	80	P
51	81	Q
52	82	R
53	83	S
54	84	T
55	85	U
56	86	V
57	87	W
58	88	X
59	89	Y
5a	90	Z
5b	91	[ (Left / Opening Bracket)
5c	92	\ (Back Slash)
5d	93	] (Right / Closing Bracket)
5e	94	^ (Caret / Circumflex)
5f	95	_ (Underscore)
60	96	' (Grave Accent)
61	97	a
62	98	b
63	99	c
64	100	d
65	101	e
66	102	f
67	103	g
68	104	h
69	105	i

6a	106	j
6b	107	k
6c	108	l
6d	109	m
6e	110	n
6f	111	o
70	112	p
71	113	q
72	114	r
73	115	s
74	116	t
75	117	u
76	118	v
77	119	w
78	120	x
79	121	y
7a	122	z
7b	123	{ (Left/ Opening Brace)
7c	124	(Vertical Bar)
7d	125	} (Right/Closing Brace)
7e	126	~ (Tilde)
7f	127	DEL (Delete)

## 16 Appendix F: Data code

0 ~ 9



0



1



2



3



4



5



6



7



8



9

A - F



A



B



C



D



E



F

## 17 Appendix G: Save or Cancel

After reading the data code, you need to scan the "save" setting code to save the data which you read. If there is an error when reading the data code, you can cancel the error reading.

For example, read a set code, and read data "A", "B", "C" and "D" in turn.

If you read "cancel the last read bit", the last read digit "D" will be cancelled.

If you read "cancel the previous read a string of data" will cancel the read data "ABCD",

If you read "cancel modification Settings", you will cancel the data "ABCD" and exit the modification Settings.



Save



Cancel the last read bit



Cancel the previous read a string of data



Cancel modification settings